



BlueSkyBio

Your Partner In Digital Dentistry

BIO | Quattro



2020

Product Catalog

BIO | Quattro

Straumann Bone Level® Compatible

January 2020

Table of contents

Implants	2
Healing Abutments	2,3
MPA Custom Abutments	3
Angled Abutments	4
KISS Abutments	4
Gold Castable Abutments	4
Plastic Castable Abutments	4
Multi Unit Abutments	5
Temporary Abutments	5
Digital Abutments	6
Intraoral Scanning Parts	6
Overdenture Abutments	6,7
Angled Overdenture Abutments	7
Analog	8
Impression Transfers	8
Surgical Instruments	9
Other Surgical Instrumentation	10

Safety Stop Surgical Kit	10,11
Fully Guided Keyless Kit	11,12
Hammerless Crestal Sinus Lift Kit	12
BIO BlueTouch	12,13
Suture	13
Master Bone Expander Kit	13
Guided Sinus Lift Kit	14
Safety Lateral Sinus Kit	14
Guide Tubes	14-18
Terms & Conditions	19

Implants

Packs include BIO | Quattro implant and 1mm cover screw.

Abutments find rotational indexing even at a significant angle to the long axis of the implant.

Screw engages the implant before abutment engages the indexing feature of the implant.

3.3mm Ø Narrow



Size	Part #
10mm	ISQ3310
12mm	ISQ3312
14mm	ISQ3314

4.1mm Ø Regular



Size	Part #
8mm	ISQ4108
10mm	ISQ4110
11.5mm	ISQ4112
13mm	ISQ4114
16mm	ISQ4116

4.8mm Ø Narrow



Size	Part #
6mm	ISQ4806
8mm	ISQ4808
10mm	ISQ4810
11.5mm	ISQ4812
13mm	ISQ4814
16mm	ISQ4816

5.6mm Ø Regular



Size	Part #
6mm	ISQ5606
8mm	ISQ5608
10mm	ISQ5610

Healing Abutments

Narrow

Size	Part #	Size	Part #	Size	Part #
3mm height	HSQN3303	3mm height	HSQN4103	3mm height	HSQN4803
5mm height	HSQN3305	5mm height	HSQN4105	5mm height	HSQN4805

Regular

Size	Part #	Size	Part #	Size	Part #
3mm height	HSQR4803	3mm height	HSQR4803	3mm height	HSQR6503

Abutments find rotational indexing even at a significant angle to the long axis of the implant.

Screw engages the implant before abutment engages the indexing feature of the implant.

All prices are available in the product section of our website. Volume discounts are available for some items.

Blue Sky Bio is not affiliated with Straumann AG. Bone Level® is a registered trademark of Straumann AG.

Regular

	Size	Part #		Size	Part #		Size	Part #
	5mm height	HSQR4105		5mm height	HSQR4805		5mm height	HSQR6505

Cover Screw

	Size	Part #		Size	Part #
	Narrow	CSQN		Regular	CSQR

MPA Abutments

3.5 Abutment Narrow Platform

	Size	Part #
	MPA Kit 3.5, Narrow	KMPASQN35
	MPA Abutment 3.5mm, Narrow	MPASQN35
	Implant Level Analog, Narrow	BISQN

4.1 Abutment Regular Platform

	Size	Part #
	MPA Kit 4.1, Regular	KMPASQR41
	MPA Abutment 4.1mm, Regular	MPASQR41
	Implant Level Analog, Regular	BISQR

4.1 Abutment Narrow Platform

	Size	Part #
	MPA Kit 4.1, Narrow	KMPASQN41
	MPA Abutment 4.1mm, Narrow	MPASQN41
	Implant Level Analog, Narrow	BISQN

4.8 Abutment Regular Platform

	Size	Part #
	MPA Kit 4.8, Regular	KMPASQR48
	MPA Abutment 4.8mm, Regular	MPASQR48
	Implant Level Analog, Regular	BISQR

4.8 Abutment Narrow Platform

	Size	Part #
	MPA Kit 4.8, Narrow	KMPASQN48
	MPA Abutment 4.8mm, Narrow	MPASQN48
	Implant Level Analog, Narrow	BISQN

6.5 Abutment Regular Platform

	Size	Part #
	MPA Kit 6.5, Regular	KMPASQR65
	MPA Abutment 6.5mm, Regular	MPASQR65
	Implant Level Analog, Regular	BISQR

Abutments find rotational indexing even at a significant angle to the long axis of the implant.

Screw engages the implant before abutment engages the indexing feature of the implant.

All prices are available in the product section of our website. Volume discounts are available for some items.

Blue Sky Bio is not affiliated with Straumann AG. Bone Level® is a registered trademark of Straumann AG.

KISS Abutments

Narrow Platform



Size	Part #
Narrow KISS Abutment 1.5mm collar	ASKSQN15

Narrow KISS Abutment 2.8mm collar ASKSQN28

Regular Platform



Size	Part #
Regular KISS Abutment 1.5mm collar	ASKSQR15

Regular KISS Abutment 2.8mm collar ASKSQR28

Regular Platform Wide Abutment



Size	Part #
Wide KISS Abutment 1.5mm collar	ASKSQW15

Wide KISS Abutment 2.8mm collar ASKSQW28

Gold Castable Abutments



Narrow Platform (Engagement)

Size	Part #
Gold UCLA Abutment (including screw)	AUCLASQNG

Additional Abutment Screw

SRSQ



Regular Platform (Engagement)

Size	Part #
Gold UCLA Abutment (including screw)	AUCLASQRG

Additional Abutment Screw

SRSQ

Plastic Castable Abutments



Narrow Platform (Non - Engagement)

Size	Part #
Plastic Non-Engagement UCLA Abutment (including screw)	PAUCSQNN

Additional Abutment Screw

SRSQ

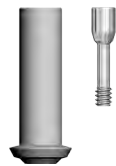

Narrow Platform (Non - Engagement)

Size	Part #
Plastic Non-Engagement UCLA Abutment (including screw)	PAUCSQNR

Additional Abutment Screw

SRSQ

Angled Abutments



Narrow Platform

Size	Part #
Angled Abutment 15 degree Unique Design Allows for 8 Positions	AASQN15

Angled Abutment 25 degree Unique Design Allows for 8 Positions AASQN25



Regular Platform

Size	Part #
Angled Abutment 15 degree Unique Design Allows for 8 Positions	AASQR15

Angled Abutment 25 degree Unique Design Allows for 8 Positions AASQR25











Abutments find rotational indexing even at a significant angle to the long axis of the implant.

Screw engages the implant before abutment engages the indexing feature of the implant.













All prices are available in the product section of our website. Volume discounts are available for some items.

Blue Sky Bio is not affiliated with Straumann AG. Bone Level® is a registered trademark of Straumann AG.







Multi Unit Abutments

Narrow Platform		Regular Platform	
Size	Part #	Size	Part #
 Abutment Multi Unit Straight, Narrow Platform, Quattro, 1.5mm cuff - Requires .080 Hex Driver	AMUSSQN15	 Abutment Multi Unit Straight, Regular Platform, Quattro, 1.5mm cuff - Requires .080 Hex Driver	AMUSSQR15
 Abutment Multi Unit Straight, Narrow Platform, Quattro, 1.5mm cuff - Requires .080 Hex Driver	AMUSSQN25	 Abutment Multi Unit Straight, Regular Platform, Quattro, 1.5mm cuff - Requires .080 Hex Driver	AMUSSQR25
 Angled Abutment Multi Unit, Narrow Platform, 17 degree, Quattro, includes abutment screw	AAMUSQN17	 Angled Abutment Multi Unit, Regular Platform, 17 degree, Quattro, includes abutment screw	AAMUSQR17
 Angled Abutment Multi Unit, Narrow Platform, 30 degree, Quattro, includes abutment screw	AAMUSQN30	 Angled Abutment Multi Unit, Regular Platform, 30 degree, Quattro, includes abutment screw	AAMUSQR30

Components

Size	Part #	Size	Part #
 Comfort Cap for all Multi Unit Abutments	CMU	 MMUTC Casting Sleeve	PWAXMUTC
 Combination Impression Transfer, Temporary Abutment and Castable Sleeve, Plastic - Requires screw SMUS or SMUL	MMUP	 Analog, Multi Unit	BMU
 Combination Impression Transfer/ Temporary Abutment - Titanium Alloy - Requires screw SMUS or SMUL	MMUT	 Angled Multi Unit Abutment Delivery Aid	DSMU
 Multiunit Coping, Temporary Abutment Titanium Alloy - Requires screw SMUS or SMUL	MMUTC	 Screw Multi Unit Impression Transfer, long	SMUL
 Multi Unit Titanium Coping Thimble	MUT	 Screw, Multi Unit, Castable Abutments, short	SMUS
 MMUTC Spacer Sleeve	PSPACEMUTC	 .080 Hex Driver for straight Multi Unit Abutments	HFD

Temporary Abutment

Narrow Platform		Regular Platform	
Size	Part #	Size	Part #
 Digital Abutment for temporary abutment, Narrow (includes abutment screw)	ABSQN	 Digital Abutment for temporary abutment, Regular (includes abutment screw)	ABSQR
 Digital Abutment for temporary abutment - non engaging, Narrow (includes abutment screw)	ABSQNN	 Digital Abutment for temporary abutment, 1.8mm collar, Regular	ABSQR18
 Digital Abutment for temporary abutment, Mini, Narrow Platform (includes abutment screw)	ABSQNMI	 Digital Abutment for temporary abutment - non engaging, Regular (includes abutment screw)	ABSQRN

Abutments find rotational indexing even at a significant angle to the long axis of the implant.

Screw engages the implant before abutment engages the indexing feature of the implant.

All prices are available in the product section of our website. Volume discounts are available for some items.

Blue Sky Bio is not affiliated with Straumann AG. Bone Level® is a registered trademark of Straumann AG.

Digital Abutment

Narrow Platform



Size	Part #
Digital Abutment for abutment and crowns for zirconia and emax (includes fixation screw)	ABSQN
Digital Abutment for temporary abutment - non engaging, Narrow (includes abutment screw)	ABSQNN
Digital Abutment Mini for abutment and crowns for zirconia and emax (includes fixation screw)	ABSQNM1

Regular Platform



Size	Part #
Digital Abutment for abutment and crowns for zirconia and emax (includes)	ABSQR
Digital Abutment for temporary abutment, 1.8mm collar, Regular	ABSQR18
Digital Abutment for temporary abutment - non engaging, Regular (includes abutment screw)	ABSQRN

Intraoral Scanning Parts

Master Overdenture Restorative Kits Regular - Chairside



Size	Part #
Rosetta Scanpost Extender for Regular Digital Abutments	OPTIBASER
Regular Ball ScanSnap (required for Exocad or 3Shape)	BALL6
Rosetta Scanpost Extender for Mini Digital Abutments	OPTIBASEN

Master Overdenture Restorative Kits Regular - Laboratory



Size	Part #
Mini Ball ScanSnap (required for Exocad / 3Shape)	BALL6MI
ScanFlag Scanpost for Regular Digital Abutments	OPTICSTB
ScanFlag Scanpost for Mini Digital Abutments	OPTICSTBMI

Overdentures

Super Snap Overdenture Restorative Kits Narrow Platform - Chairside Requires No Metal Housing



Size	Part #
Super Insert Restorative Kits - Chairside, narrow x 1.5mm height	SIRKSQTN15



Super Insert Restorative Kit - Chairside, narrow x 3.0mm height	SIRKSQTN30
---	------------



Super Insert Restorative Kit - Chairside, narrow x 5.0mm height	SIRKSQTN50
---	------------

Super Snap Overdenture Restorative Kits Narrow Platform - Laboratory Requires No Metal Housing



Size	Part #
Super Insert Restorative Kits - Laboratory, narrow x 1.5mm height	SIRKSQTN15-L



Super Insert Restorative Kits - Laboratory, narrow x 3.0mm height	SIRKSQTN30-L
---	--------------



Super Insert Restorative Kits - Laboratory, narrow x 5.0mm height	SIRKSQTN50-L
---	--------------

Abutments find rotational indexing even at a significant angle to the long axis of the implant.

Screw engages the implant before abutment engages the indexing feature of the implant.



All prices are available in the product section of our website. Volume discounts are available for some items.

Blue Sky Bio is not affiliated with Straumann AG. Bone Level® is a registered trademark of Straumann AG.

Super Snap Overdenture Restorative Kits Regular Platform - Chairside Requires No Metal Housing

	Size	Part #
	Super Insert Restorative Kits - Chairside, regular x 1.5mm height	SIRKSQTR15
	Super Insert Restorative Kit - Chairside, regular x 3.0mm height	SIRKSQTR30
	Super Insert Restorative Kit - Chairside, regular x 5.0mm height	SIRKSQTR50

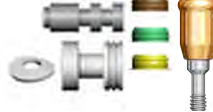
Super Snap Overdenture Restorative Kits Regular Platform - Laboratory Requires No Metal Housing

	Size	Part #
	Super Insert Restorative Kits - Laboratory, regular x 1.5mm height	SIRKSQTR15-L
	Super Insert Restorative Kits - Laboratory, regular x 3.0mm height	SIRKSQTR30-L
	Super Insert Restorative Kits - Laboratory, regular x 5.0mm height	SIRKSQTR50-L

Angled Overdentures

Angled Super Overdenture Restorative Kit Narrow Platform - Chairside Requires No Metal Housing

	Size	Part #
	Angled Super Overdenture Restorative Kit Narrow Platform, 17 degrees - Chairside	ASRKSQN17
	Angled Super Overdenture Restorative Kit Narrow Platform, 30 degrees - Chairside	ASRKSQN30

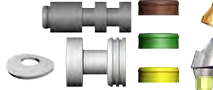
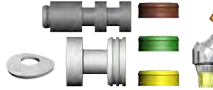

Angled Super Overdenture Restorative Kit Narrow Platform - Laboratory Requires No Metal Housing

	Size	Part #
	Angled Super Overdenture Restorative Kit Narrow Platform, 17 degrees - Laboratory	ASRKSQN17-L
	Angled Super Overdenture Restorative Kit Narrow Platform, 30 degrees - Laboratory	ASRKSQN30-L

Angled Super Overdenture Restorative Kit Regular Platform - Chairside Requires No Metal Housing

	Size	Part #
	Angled Super Overdenture Restorative Kit Regular Platform, 17 degrees - Chairside	ASRKSQR17
	Angled Super Overdenture Restorative Kit Regular Platform, 30 degrees - Chairside	ASRKSQR30

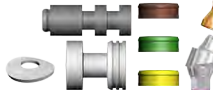
Angled Super Overdenture Restorative Kit Regular Platform - Laboratory Requires No Metal Housing

	Size	Part #
	Angled Super Overdenture Restorative Kit Regular Platform, 17 degrees - Laboratory	ASRKSQR17-L
	Angled Super Overdenture Restorative Kit Regular Platform, 30 degrees - Laboratory	ASRKSQR30-L

Abutments find rotational indexing even at a significant angle to the long axis of the implant.







Screw engages the implant before abutment engages the indexing feature of the implant.

All prices are available in the product section of our website. Volume discounts are available for some items.



Blue Sky Bio is not affiliated with Straumann AG. Bone Level® is a registered trademark of Straumann AG.

Overdenture Products

	Size	Part #
	Complete Flat Snap Restorative Kit	NOPK
	Analog	FSA
	Replacement Inserts Strong Retention (4 Pack)	FSCS
	Replacement Inserts Medium / Light Retention (4 Pack)	FSCG
	Resin Impression transfer (2 Pack) and FSCB (4 Pack)	FSCR
	Processing Inserts No Retention (4 Pack)	FSCB
	Super Insert – Strong retention, requires no housing (includes 2 inserts and 2 block out rings) Extreme long lasting retention on parallel implants.	FOPS
	Super Insert – Medium retention, requires no housing (includes 2 inserts and 2 block out rings) Extreme long lasting retention on parallel implants.	FOPG

	Size	Part #
	Super Insert – Light retention, requires no housing (includes 2 inserts and 2 block out rings) Extreme long lasting retention on parallel implants.	FOPR
	Resin Impression transfer (2 Pack)	FSI
	Titanium Housing	HGFS
	Block Out Ring (10 Pack)	RSD01
	Insert Placement/Removal Instrument	TFSU
	Insert Placement/Removal Instrument	TFSU

Analogs

Narrow Platform (Engagement)		
Size	Part #	
	Implant Level Analog, Narrow	BISQN
	Implant Level Analog, Regular	BISQR

Implant Level Impression Transfers

Closed Tray Impression Narrow Platform

Size	Part #
 Closed Tray Impression Transfer. Narrow	MSQN

Closed Tray Impression Regular Platform

Size	Part #
 Closed Tray Impression Transfer. Regular	MSQR

Open Tray Impression Narrow Platform

Size	Part #
 Open Tray Impression Transfer. Narrow	MSQN-OT

Open Tray Impression Regular Platform

Size	Part #
 Open Tray Impression Transfer. Regular	MSQR-OT

Abutments find rotational indexing even at a significant angle to the long axis of the implant.

Screw engages the implant before abutment engages the indexing feature of the implant.







All prices are available in the product section of our website. Volume discounts are available for some items.

Blue Sky Bio is not affiliated with Straumann AG. Bone Level® is a registered trademark of Straumann AG.

Surgical Instruments

Surgical Instruments	
Size	Part #
	Torque/Ratchet Wrench TR-900-01
	Thumbwheel/ITI Wrench Adapter ITI-Adapter
	.048 Hex Driver short SDS048
	.048 Hex Driver long SDL048
	Handpiece Implant Driver Narrow, Short DMSQN
	Handpiece Implant Driver Narrow, Long DMLQN
	Handpiece Implant Driver Regular, Short DMSQR
	Handpiece Implant Driver Regular, Long DMLQR
	Ratchet Implant Driver Narrow, Short DTSQN
	Ratchet Implant Driver Narrow, Long DTLQN
	Ratchet Implant Driver Regular, Short DTSQR
	Ratchet Implant Driver Regular, Long DTLQR
	Drill Starter, short DRILLTSS
	Drill Starter, long DRILLTSL
	Drill 2.2mm, short DRILLT22S
	Drill 2.2mm, long DRILLT22L
	Drill 2.8mm, short DRILLT28S
	Drill 2.8mm, long DRILLT28L
	Drill 3.5mm, short DRILLT35S
	Drill 3.5mm, long DRILLT35L
	Drill 4.3mm, short DRILLT43S
	Drill 4.3mm, long DRILLT43L
	Drill 5.0mm, short DRILLT50S
	Instrument Box QOIB
	Complete Surgical Kit QCSK

Other Surgical Instrumentation









	Size	Part #
	Lindemann Bur	LINDR-S21
	Lance Drill	LD150
	Trepine Bur	TPHB-B6
	Final Drill for 7.0mm Implant, short	DRILL6653S
	Angled Screw Driver (20Ncm max torque)	SDUGA
	Screw Removal Tool	AFSR

Safety Stop Surgical Kit



Part #	Part #
Safety Stop Surgical Kit	SSSQ

Safety Stop Kit Individual Components And Accessories

	Size	Part #
	Drill Starter	DRILNSTPS
	Drill Stop 2.2 x 6mm	DRILTSTP2206
	Drill Stop 2.2 x 8mm	DRILTSTP2208
	Drill Stop 2.2 x 10mm	DRILTSTP2210
	Drill Stop 2.2 x 12mm	DRILTSTP2212
	Drill Stop 2.8 x 6mm	DRILTSTP2806
	Drill Stop 2.8 x 8mm	DRILTSTP2808
	Drill Stop 2.8 x 10mm	DRILTSTP2810
	Drill Stop 2.8 x 12mm	DRILTSTP2812
	Drill Stop 3.5 x 6mm	DRILTSTP3506
	Drill Stop 3.5 x 8mm	DRILTSTP3508
	Drill Stop 3.5 x 10mm	DRILTSTP3510







Abutments find rotational indexing even at a significant angle to the long axis of the implant.

Screw engages the implant before abutment engages the indexing feature of the implant.

All prices are available in the product section of our website. Volume discounts are available for some items.

Blue Sky Bio is not affiliated with Straumann AG. Bone Level® is a registered trademark of Straumann AG.

Safety Stop Kit Individual Components And Accessories









	Size	Part #
	Drill Stop 3.5 x 12mm	DRILTSTP3512
	Drill Stop 4.3 x 6mm	DRILTSTP4306
	Drill Stop 4.3 x 8mm	DRILTSTP4308
	Drill Stop 4.3 x 10mm	DRILTSTP4310
	Drill Stop 4.3 x 12mm	DRILTSTP4312
	Drill Stop Drill Extender	TDE

Fully Guided Keyless Kit



	Part #
Fully Guided Keyless Kit	GSKQ
Master Cylinder for Fully Guided Kit (Cerec M Master Tube Compatible)	Tube524-504-4L
Master Cylinder for Fully Guided Kit (Cerec M Master Tube Compatible)	TUBE524-504-4LNF
Master Cylinder for Fully Guided Kit (Cerec L Master Tube Compatible)	Tube59-504-45L

Guided Kit Individual Components And Accessories

	Size	Part #
	Guided Drill, Quattro, 2.2 x 6mm	DRILTG2206
	Guided Drill, Quattro, 2.2 x 8mm	DRILTG2208
	Guided Drill, Quattro, 2.2 x 10mm	DRILTG2210
	Guided Drill, Quattro, 2.2 x 12mm	DRILTG2212
	Guided Drill, Quattro, 2.8 x 6mm	DRILTG2806
	Guided Drill, Quattro, 2.8 x 8mm	DRILTG2808
	Guided Drill, Quattro, 2.8 x 10mm	DRILTG2810
	Guided Drill, Quattro, 2.8 x 12mm	DRILTG2812
	Guided Drill, Quattro, 3.5 x 6mm	DRILTG3506













Abutments find rotational indexing even at a significant angle to the long axis of the implant.

Screw engages the implant before abutment engages the indexing feature of the implant.



All prices are available in the product section of our website. Volume discounts are available for some items.

Blue Sky Bio is not affiliated with Straumann AG. Bone Level® is a registered trademark of Straumann AG.

Guided Kit Individual Components And Accessories

	Size	Part #
	Guided Drill, Quattro, 3.5 x 8mm	DRILTG3508
	Guided Drill, Quattro, 3.5 x 10mm	DRILTG3510
	Guided Drill, Quattro, 3.5 x 12mm	DRILTG3512
	Guided Drill, Quattro, 4.3 x 6mm	DRILTG4306
	Guided Drill, Quattro, 4.3 x 8mm	DRILTG4308
	Guided Drill, Quattro, 4.3 x 10mm	DRILTG4310
	Guided Drill, Quattro, 4.3 x 12mm	DRILTG4312
	Bone Crest Flattening Drill	DRILGFLAT
	Guided Implant Driver, Quattro	DMGSQNV
	Guided Implant Driver, Quattro	DMGSQRV
	Guided Implant Driver, Quattro	DTGSQNV
	Guided Implant Driver, Quattro	DTGSQRV
	Guide Fixation Pin (5 Pack)	PIN

Hammerless Crestal Sinus Lift Kit

Sinus Lift Kit		
	Size	Part #
	Hammerless Atraumatic Crestal Sinus Lift Kit	Sinus Kit
	Addition Guide Pin	GPINMAXNP

BIO | BlueTouch

	Size	Part #
	Touch-Screen Implant Motor (Adjustable Speed 300 – 40,000 RPM; up to 50 Ncm of torque for placement). Does not include handpiece.	BIO-BT

Abutments find rotational indexing even at a significant angle to the long axis of the implant.

Screw engages the implant before abutment engages the indexing feature of the implant.

All prices are available in the product section of our website. Volume discounts are available for some items.

Blue Sky Bio is not affiliated with Straumann AG. Bone Level® is a registered trademark of Straumann AG.

	Size	Part #
	Saeshin Strong 20:1 Handpiece External Irrigation (button)	ACL(B)-411
	Saeshin Traus 20:1 Non-Optic Handpiece External Irrigation (button)	CRB26XX
	Anthogyr Impulsion 20:1 Contra Angle (brush type); 50 Ncm tolerance	AHP-85P-I
	Anthogyr Mont Blanc 20:1 Contra Angle (high efficiency); 80 Ncm tolerance	AHP-85MB-X
	Anthogyr Mont Blanc 20:1 Contra Angle with Depth Control (high efficiency); 80 Ncm tolerance	AHP-85MB-CX

	Size	Part #
	Saeshin Strong 1:1 Straight Handpiece External Irrigation	AT-11
	Nozzle Clip 1:1 Straight Handpiece	ST-Nozzle
	Autoclavable Tubing Set for BIO BlueTouch	AE-24
	Autoclavable Pump Section for AE-24 Tubing Set	AE-24-PUMP
	Synthetic Premium Handpiece Lubricant	LU1011HS
	Lubricant Tool Attachment (necessary for lubricant)	LT1013HS

Sutures

All sutures are 60cm in length with reverse cutting needles and packaged 12 per box. Sutures sales are currently limited to U.S. customers.

	Size	Part #
	PGA Fast Resorb 4-0, FS-2 needle, 12/box	PGF40FS2
	PGA 4-0 violet, FS-2 needle, 12/box	PG40FS2
	Polypropylene (unbraided black) 5-0, P3 needle, 12/box	P50P3

	Size	Part #
	Nylon (unbraided black) 5-0, P3 needle, 12/box	N50P3
	Silk 3-0, FS-2 needle, 12/box	S30FS2

Master Bone Expander Kit

Master Bone Expander Kit includes the Bone Expander Kit and four Lerner Ridge Splitting Chisels.

Master Bone Expander Kit		
	Size	Part #
	Master Bone Expander Kit	MBEK

Bone Expander Kit		
	Size	Part #
	Bone Expander Kit	BEK

Lerner Ridge Splitting Chisels		
	Size	Part #
	3mm Chisel with 2mm blade thickness	RSC32
	3mm Chisel with .5mm blade thickness	RSC35
	6mm Chisel with 2mm blade thickness	RSC62
	6mm Chisel with .5mm blade thickness	RSC65

Abutments find rotational indexing even at a significant angle to the long axis of the implant.

Screw engages the implant before abutment engages the indexing feature of the implant.

All prices are available in the product section of our website. Volume discounts are available for some items.

Blue Sky Bio is not affiliated with Straumann AG. Bone Level® is a registered trademark of Straumann AG.

Guided Sinus Lift Kit

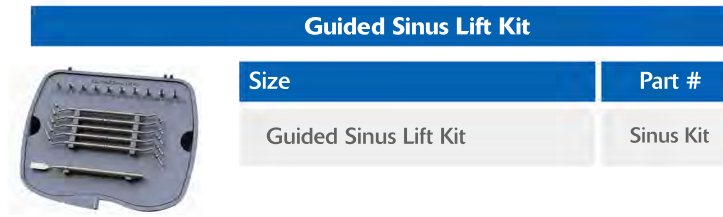

Safety Lateral Sinus Kit

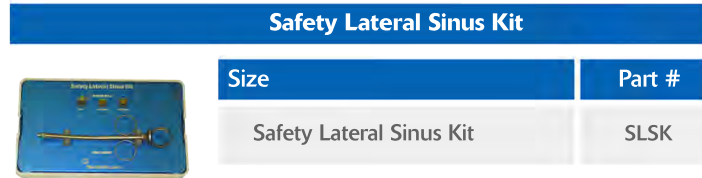

Guide Tubes

Guide Tubes			
Size	Part #	Size	Part #
1.2 Guide Tube (5 Pack) ID=1.2mm OD=2.2mm Height=4mm Lip=1mm of total height	TUBE22-12-4L	1.9 Guide Tube (5 Pack) ID=1.9mm OD=2.9mm Height=4mm Lip=1mm of total height	TUBE29-19-4L
1.4 Guide Tube (5 Pack) ID=1.4mm OD=2.4mm Height=4mm Lip=1mm of total height	TUBE24-14-4L	2.0 Guide Tube (5 Pack) ID=2.0mm OD=3.0mm Height=4mm Lip=1mm of total height	TUBE3-2-4L
1.55 Guide Tube (5 Pack) ID=1.55mm OD=2.55mm Height=7mm		2.0 Guide Tube (5 Pack) ID=2.0mm OD=3.0mm Height=5mm Lip=1mm of total height	Tube20
1.6 Guide Tube (5 Pack) ID=1.6mm OD=2.6mm Height=4mm Lip=1mm of total height	TUBE26-16-4L	2.1 Guide Tube (5 Pack) ID=2.1mm OD=3.1mm Height=4mm Lip=1mm of total height	TUBE31-21-4L
1.7 Guide Tube (5 Pack) ID=1.7mm OD=2.7mm Height=4mm Lip=1mm of total height	TUBE27-17-4L	2.1 Guide Tube ID=2.1mm OD=3.0mm Height=5mm Lip=1mm of total height	TUBE3-21-5L

Abutments find rotational indexing even at a significant angle to the long axis of the implant.

Screw engages the implant before abutment engages the indexing feature of the implant.

All prices are available in the product section of our website. Volume discounts are available for some items.

Blue Sky Bio is not affiliated with Straumann AG. Bone Level® is a registered trademark of Straumann AG.

Guide Tubes

Size	Part #	Size	Part #
2.1 Guide Tube ID=2.1mm OD=4.0mm Height=5mm Lip=1mm of total height	TUBE4-21-5L	2.4 Guide Tube (5 Pack) ID=2.4mm OD=3.4mm Height=4mm Lip=1mm of total height	TUBE34-24-4L
2.1 Guide Tube ID=2.1mm OD=5.0mm Height=5mm Lip=1mm of total height	TUBE5-21-5L	2.4 Guide Tube ID=2.4mm OD=4.0mm Height=5mm Lip High=1mm of total height Lip Wide=.5mm	TUBE4-24-5L
2.11 Guide Tube (5 Pack) ID=2.11mm OD=3.11mm Height=5mm Lip=1mm of total height	Tube211	2.4 Guide Tube ID=2.4mm OD=3.0mm Height=5mm Lip=1mm of total height	TUBE3-24-5L
2.2 Guide Tube (5 Pack) ID=2.2mm OD=3.2mm Height=5mm Lip=1mm of total height	Tube22	2.4 Guide Tube ID=2.4mm OD=5.0mm Height=5mm Lip=1mm of total height	TUBE5-24-5L
2.3 Guide Tube ID=2.3mm OD=3.0mm Height=5mm Lip=1mm of total height	TUBE3-23-5L	2.6 Guide Tube ID=2.6mm OD=4.0mm Height=5mm Lip=1mm of total height	TUBE4-26-5L
2.3 Guide Tube ID=2.3mm OD=4.0mm Height=5mm Lip High=1mm of total height Lip Wide=.5mm	TUBE4-23-5L	2.72 Guide Tube ID=2.72mm OD=4.4mm Height=5mm Lip=1mm of total height	TUBE44-272
2.3 Guide Tube ID=2.3mm OD=5.0mm Height=5mm Lip=1mm of total height	TUBE5-23-5L	2.8 Guide Tube (5 Pack) ID=2.8mm OD=3.8mm Height=5mm Lip=1mm of total height	TUBE280
2.31 Guide Tube (5 Pack) ID=2.31mm OD=3.31mm Height=5mm Lip=1mm of total height	Tube231	2.8 Guide Tube ID=2.8mm OD=4.0mm Height=5mm Lip=1mm of total height	TUBE4-28-5L
2.8 Guide Tube ID=2.8mm OD=5.0mm Height=5mm Lip=1mm of total height	TUBE5-28-5L	3.3 Guide Tube ID=3.3mm OD=5.0mm Height=5mm Lip=1mm of total height	TUBE5-33-5L
2.9 Guide Tube ID=2.9mm OD=4.0mm Height=5mm Lip=1mm of total height	TUBE4-29-5L	3.5 Guide Tube ID=3.5mm OD=4.0mm Height=5mm Lip=1mm of total height	TUBE4-35-5L

Abutments find rotational indexing even at a significant angle to the long axis of the implant.

Screw engages the implant before abutment engages the indexing feature of the implant.

All prices are available in the product section of our website. Volume discounts are available for some items.

Blue Sky Bio is not affiliated with Straumann AG. Bone Level® is a registered trademark of Straumann AG.

Guide Tubes

Size	Part #	Size	Part #
2.9 Guide Tube ID=2.9mm OD=5.0mm Height=5mm Lip=1mm of total height	TUBE5-29-5L	3.5 Guide Tube ID=3.5mm OD=5.0mm Height=5mm Lip=1mm of total height	TUBE5-35-5L
2.9 Guide Tube ID=2.9mm OD=5.0mm Height=5mm Lip=1mm of total height	TUBE5-29-5L	3.6 Guide Tube ID=3.6mm OD=4.0mm Height=5mm Lip=1mm of total height	TUBE4-36-5L
2.92 Guide Tube (5 Pack) ID=2.92mm OD=3.92mm Height=5mm Lip=1mm of total height	TUBE292	3.68 Guide Tube (5 Pack) 3.5mm Short/Long, Bio Trilobe ID=3.68mm OD=4.68mm Height=5mm Lip=1mm of total height	TUBE368
3.0 Guide Tube ID=3.0mm OD=5.0mm Height=5mm Lip=1mm of total height	TUBE5-3-5L	3.75 Guide Tube ID=3.75mm OD=4.4mm Height=5mm Lip=1mm of total height	TUBE44-375
3.15 Guide Tube ID=3.15mm OD=4.4mm Height=5mm Lip=1mm of total height	TUBE44-315	3.79 Guide Tube ID=3.79mm OD=4.4mm Height=5mm Lip=1mm of total height	TUBE44-379
3.3 Guide Tube ID=3.3mm OD=4.0mm Height=5mm Lip=1mm of total height	TUBE4-33-5L	3.9 Guide Tube ID=3.9mm OD=5.0mm Height=5mm Lip=1mm of total height	TUBE5-39-5L
4.1 Guide Tube ID=4.1mm OD=5.0mm Height=4mm Lip=1mm of total height	TUBE5-41-4L	4.45 Guide Tube (5 Pack) 4.3mm Short / Long, Bio Trilobe ID=4.45mm OD=5.45mm	TUBE445
4.1 Guide Tube (5 Pack) ID=4.1mm OD=5.1mm Height=3.5mm Lip=1mm of total height	TUBE51-41-35L	4.52 Guide Tube ID=4.52mm OD=5.57mm Height=4mm Lip=1mm of total height	TUBE557-452-4L
4.15 Guide Tube (5 Pack) ID=4.15mm OD=5.15mm Height=5mm Lip=1mm of total height	TUBE415	4.68 Guide Tube ID=4.68mm OD=5.3mm Height=5mm Lip=1mm of total height	TUBE53-468
4.2 Guide Tube ID=4.2mm OD=5.0mm Height=4.5mm Lip=1mm of total height	TUBE5-42-45L	4.7 Guide Tube (5 Pack) ID=4.7mm OD=5.7mm Height=4mm Lip=1mm of total height	TUBE57-47-4L

Abutments find rotational indexing even at a significant angle to the long axis of the implant.

Screw engages the implant before abutment engages the indexing feature of the implant.

All prices are available in the product section of our website. Volume discounts are available for some items.

Blue Sky Bio is not affiliated with Straumann AG. Bone Level® is a registered trademark of Straumann AG.

Guide Tubes

Size	Part #	Size	Part #
4.25 Guide Tube (5 Pack) ID=4.25mm OD=5.25mm Height=4mm Lip=1mm of total height	TUBE525-425-4L	5.0 Guide Tube (5 Pack) ID=5.0mm OD=6.0mm Height=3.5mm Lip=1mm of total height	TUBE6-5-35L
4.25 Guide Tube (5 Pack) ID=4.25mm OD=5.25mm Height=5mm Lip=1mm of total height	TUBE425	5.0 Guide Tube ID=5.0mm OD=6.2mm Height=4mm Lip=1mm of total height	TUBE62-5-4L
4.25 Guide Tube ID=4.25mm OD=5.3mm Height=5mm Lip=1mm of total height	TUBE53-425	5.02 Guide Tube (5 Pack) ID=5.02mm OD=6.02mm Height=5mm Lip=1mm of total height	TUBE502
4.35 Guide Tube ID=4.35mm OD=5.27mm Height=6mm Lip=1mm of total height	TUBE527-435-6L	5.06 Guide Tube (5 Pack) ID=5.06mm OD=6.02mm Height=3.5mm Lip=1mm of total height	TUBE6-506-35L
5.08 Guide Tube (5 Pack) ID=5.08mm OD=6.08mm Height=5mm Lip=1mm of total height	TUBE508	5.5 Guide Tube ID=5.5mm OD=6.5mm Height=4mm Lip=1mm of total height	TUBE65-55-4L
5.1 Guide Tube ID=5.1mm OD=6.1mm Height=6mm Lip=1mm of total height	TUBE61-51-6L	5.7 Guide Tube (5 Pack) ID=5.7mm OD=6.7mm Height=4mm Lip=1mm of total height	TUBE67-57-4L
5.15 Guide Tube (5 Pack) ID=5.15mm OD=6.15mm Height=4mm Lip=1mm of total height	TUBE615-515-4L	6.13 Guide Tube ID=6.13mm OD=6.95mm Height=3.2mm Lip=1mm of total height	TUBE695-613-32L
5.15 Guide Tube (5 Pack) ID=5.15mm OD=6.15mm Height=4mm Lip=1mm of total height	TUBE615-515-4L	6.13 Guide Tube ID=6.13mm OD=6.95mm Height=3.2mm Lip=1mm of total height	TUBE695-613-32L
5.16 Guide Tube (5 Pack) 5.0mm Short, Bio Trilobe ID=5.16mm OD=6.16mm Height=5mm Lip=1mm of total height	TUBE516	6.2 Guide Tube ID=6.2mm OD=6.9mm Height=4mm Lip=1mm of total height	TUBE69-62-4L
5.25 Guide Tube (5 Pack) ID=5.25mm OD=6.25mm Height=4mm Lip=1mm of total height	TUBE625-525-4L	6.2 Guide Tube (5 Pack) ID=6.2mm OD=7.2mm Height=3.5mm Lip=1mm of total height	TUBE72-62-35L

Abutments find rotational indexing even at a significant angle to the long axis of the implant.

Screw engages the implant before abutment engages the indexing feature of the implant.

All prices are available in the product section of our website. Volume discounts are available for some items.

Blue Sky Bio is not affiliated with Straumann AG. Bone Level® is a registered trademark of Straumann AG.

Guide Tubes

Size	Part #	Size	Part #
5.25 Guide Tube (5 Pack) ID=5.25mm OD=6.25mm Height=5mm Lip=1mm of total height	TUBE525	6.26 Guide Tube (5 Pack) ID=6.26mm OD=7.21mm Height=3.5mm Lip=1mm of total height	TUBE72-626-35L
5.31 Guide Tube ID=5.31mm OD=6.2mm Height=4.5mm Lip=1mm of total height	TUBE62-531-45L	6.3 Guide Tube ID=6.3mm OD=7.3mm Height=6mm Lip=1mm of total height	TUBE73-63-6L
5.35 Guide Tube (5 Pack) ID=5.35mm OD=6.35mm Height=4mm Lip=1mm of total height	TUBE635-535-4L	6.72 Guide Tube ID=6.72mm OD=7.17mm Height=5mm Lip=1mm of total height	TUBE717-672

Abutments find rotational indexing even at a significant angle to the long axis of the implant.

Screw engages the implant before abutment engages the indexing feature of the implant.

All prices are available in the product section of our website. Volume discounts are available for some items.

Blue Sky Bio is not affiliated with Straumann AG. Bone Level® is a registered trademark of Straumann AG.

Terms and Conditions

TERMS AND CONDITIONS – Important User Information

Blue Sky Bio, LLC offers high quality dental implant products at much lower prices, compared to its competitors. To help keep our overhead low and prices value-minded, we only accept returns or exchanges under very limited circumstances.

RETURNS & EXCHANGES

Blue Sky Bio will accept returns or exchanges within 30 days of original sales receipt. Products returned or exchanged between 31 and 120 days of original sales receipt are subject to a 15% restocking fee. No products can be returned or exchanged after 120 days from date of original sales receipt. Prior to return or exchange please contact us for a Return Authorization Number (RA#). All returned or exchanged products are subject to inspection. Products that have been opened, damaged or marked upon are not eligible for return or exchange. When your products arrive, inspect the packaging and the contents for damage and defects. You must notify us within 7 days from date of original sales receipt if, product packaging is damaged, illegible, or has a broken safety seal; or if product itself appears to be damaged or does not function as its intended use. In these cases, Blue Sky Bio will pay return shipping charges, and will pay shipping charges of replacement products. Blue Sky Bio does not offer a credit or reimburse for implants that do not integrate.

ORDER PLACEMENT

Blue Sky Bio accepts payment for purchases with Visa, MasterCard, and American Express, through its secure website. Prices for products, sales tax, shipping, or any other charges will be listed on your sales receipt. Full payment is due before orders are shipped. Sales are final after shipment has left our distribution center. Blue Sky Bio reserves the right to hold orders until credit card information can be confirmed. You may be contacted by a Blue Sky Bio representative regarding your purchase. Title to products, for both domestic and international shipments, will pass to the buyer when products are delivered to the carrier.

SHIPPING

Orders shipped within the United States are generally shipped via UPS. Orders shipped outside the United States are shipped via Fedex. Customers are ultimately responsible to ensure that carriers will deliver at the requested time in their areas. Orders placed before 1:30pm CST will ship the same day. Orders placed after 1:30pm CST may not ship until the next business day. Blue Sky Bio recognizes holidays throughout the year. Watch our home page for notices regarding company closings due to holidays. Blue Sky Bio and carriers are not responsible for late arrivals due to poor weather conditions, supplied shipping address errors or failed delivery attempts.

INTERNATIONAL BROKER / TAX TERMS

Blue Sky Bio utilizes Fedex Express (FE) to ship and broker all orders from the United States to your door. As broker, FE pays all taxes, tariffs, and VAT due on shipments. FE will bill you separately for these charges after you receive your order, including their broker fee. Taxes and broker fees are not part of your shipping charge collected at time of order. By placing your order you authorize Blue Sky Bio to collect any taxes not paid, as soon as reported by FE of tax delinquency, via your credit card on file. You will be responsible for any additional charges or late fees associated with not paying responsible taxes, tariffs, and VAT promptly.

CONTACTING BLUE SKY BIO

Contacting us is very easy and convenient. Call us toll-free 9am - 5pm CST at, 888-446-6724, or email us anytime at, info@blueskybio.com.

IMPORTANT PRODUCT NOTICES FOR BLUE SKY BIO CUSTOMERS

BIO | Quattro is Straumann bone level Compatible.

Blue Sky Bio is not affiliated with Straumann bone level Compatible. Straumann bone level Compatible is a registered trademark of Straumann.